

HD CCTV Total Solution

IR Dome Camera User Manual

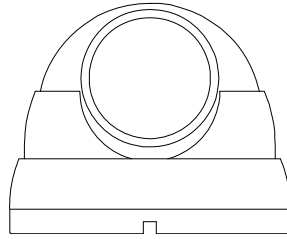

The product image shown above may differ from the actual product.
Please use this camera with a DVR which supports HD video recording.
Please read the instructions thoroughly before using the product.



CAUTION

RISK OF ELECTRIC SHOCK



CAUTION:

To reduce the risk of electric shock, do not expose this apparatus to rain or moisture.

Only operate this apparatus from the type of power source indicated on the label.

The company shall not be liable for any damages arising out of any improper use, even if we have been advised of the possibility of such damages.



The lightning flash with arrowhead symbol, within an equilateral triangle, is intended to alert the user to the presence of uninsulated "dangerous voltage" within the product's enclosure that may be of sufficient magnitude to constitute a risk of electric shock to persons.



This exclamation point within an equilateral triangle is intended to alert the user to the presence of important operating and maintenance (servicing) instructions in the literature accompanying the appliance.



ROHS Announcement

All lead-free products offered by the company comply with the requirements of the European law on the Restriction of Hazardous Substances (RoHS) directive, which means our manufacture processes and products are strictly "lead-free" and without the hazardous substances cited in the directive.



The crossed-out wheeled bin mark symbolizes that within the European Union the product must be collected separately at the product end-of-life. This applies to your product and any peripherals marked with this symbol. Do not dispose of these products as unsorted municipal waste.



CE Mark

This apparatus is manufactured to comply with the radio interference.

The company does not warrant that this manual will be uninterrupted or error-free. We reserve the right to revise or remove any content in this manual at any time.

FEATURES

1. 1/2.7" CMOS sensor with 1080P video output
2. Low light sensitivity of 0.1 Lux / F1.6(Wide)~F2.8(Tele), 0 Lux (IR LED ON)
3. Camera focus and parameters adjustable remotely from AVTECH HD CCTV DVR
4. DWDR to increase image recognizability in overexposure and dark areas
5. Day and night 24-hour surveillance with IR effective distance up to 50 meters
6. IP66 for weather-proof application

PACKAGE CONTENT

- IR dome camera
- Camera case
- User manual
- Screws & wall plugs

DIMENSIONS*

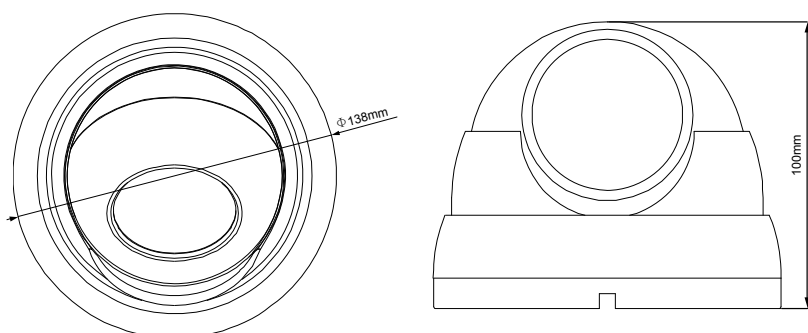

*Dimensional Tolerance: ± 5mm

SPECIFICATIONS*

Pick-up Element	1/ 2.7" CMOS image sensor
Number of Pixels	1936(H) x 1096(V)
Video Frame Rate	1080P@30fps / 1080P@25fps
Min. Illumination	0.1 Lux / F1.6(Wide)~F2.8(Tele), 0 Lux (IR LED ON)
S/N Ratio	More than 48dB (AGC OFF)
Shutter Speed	1/30 (1/25) sec ~ 1/720000 (1/600000) sec
Lens	Motorized f2.8 ~ f8.0mm / F1.6 ~ F2.8
Lens Angle	Wide: 104° (Horizontal) / 56° (Vertical) / 126° (Diagonal) Tele: 57° (Horizontal) / 32° (Vertical) / 65° (Diagonal)
IR LED	4 units
IR Effective Distance	Up to 50 meters
IR Shift	YES
Day & Night Mode	YES
IRIS Mode	AES
White Balance	AUTO / INDOOR / OUTDOOR / MANUAL
AGC	Adjustable
Sharpness	Adjustable
Flickerless	50HZ / 60HZ / OFF
BLC	Adjustable
DWDR	YES
IP Rating	IP66
Operating Temperature	-25°C ~ 50°C
Operating Humidity	90% or less relative humidity
Power Source (±10%)	DC12V / 1A
Current consumption (±10%)	130mA (IR LED OFF) / 450mA (IR LED ON)
Net weight (kg)	0.75

* The specifications are subject to change without notice.

INSTALLATION

Step1: Disassemble the camera case into three parts as illustrated in *Figure 1*.

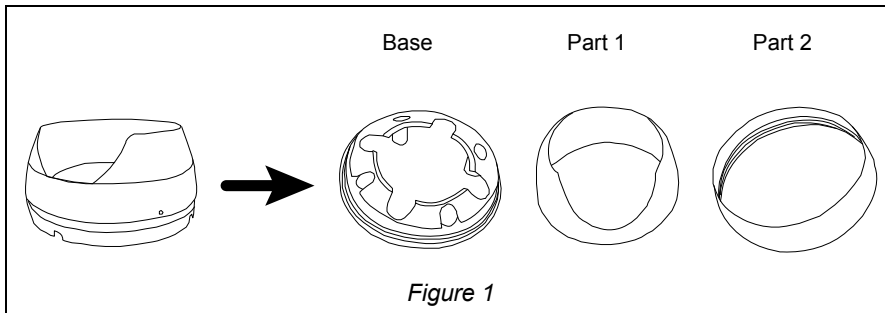

Step2: Locate where you want to install this camera (wall or ceiling), and drill holes on the wall or ceiling for securing the bracket and routing the cables (if necessary).

Step3: Attach the bracket to the wall (or ceiling), and make sure the cables are routed and arranged properly in the bracket, as shown in *Figure 2*.

Step4: Secure the bracket to the wall (or ceiling), as shown in *Figure 3*.

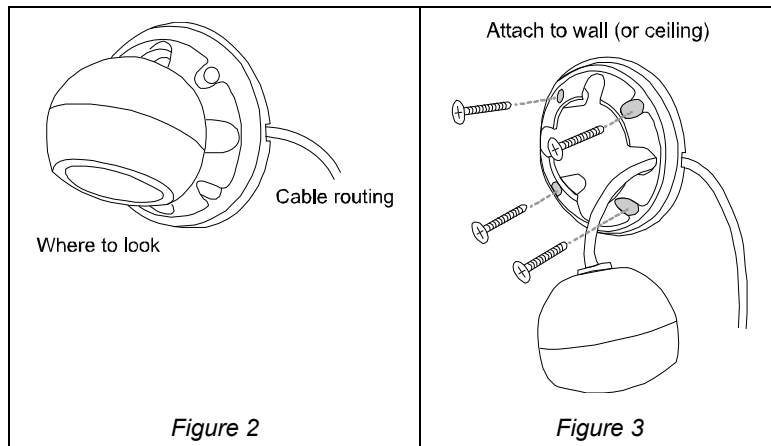

Step5: Slightly adjust the camera lens to where it's supposed to face, and replace Part 1 and Part 2 back, as shown in *Figure 4* and *Figure 5*.

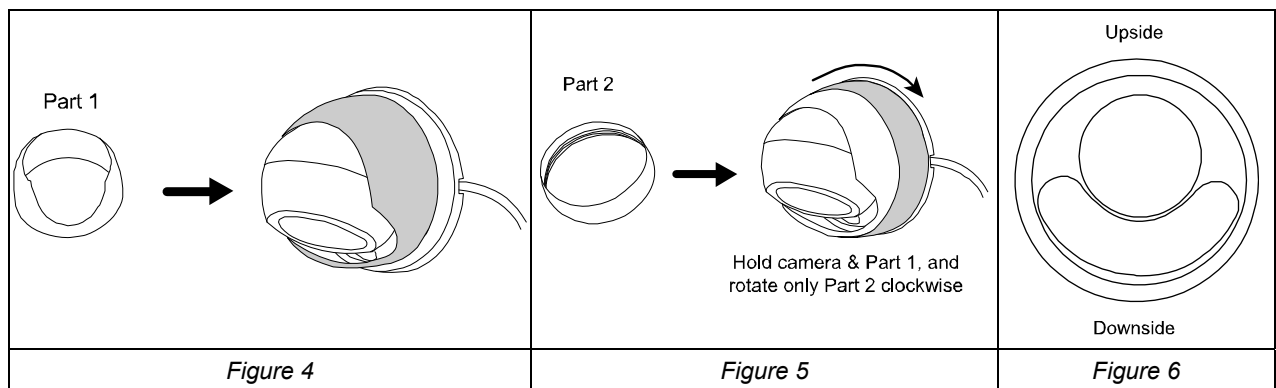

Step6: Hold the camera lens and Part 1, and rotate only Part 2 clockwise until it's fastened, as shown in *Figure 5*.

NOTE: Do not install the lens upside down. (Refer to *Figure6*)

Step7: Power on the camera and fine-tune the viewing angle.

For details, please refer to the section, "**FOCAL LENGTH & FOCUS ADJUSTMENT**".

CONNECTION

1. DC12V Input Terminal

Connect the power terminal of the camera to a DC 12V regulated power supply.

Note: Please use the correct power adaptor, DC12V (regulated), to operate this unit. The power tolerance of this unit is DC12V \pm 10%. Over maximum DC 12V power input will damage this unit.

2. Video Output Connector (VIDEO OUT)

Connect the camera video output to the video input of a DVR with 75 Ω coaxial cable.





Note: To ensure the camera has sufficient protection against moisture, an extra waterproof measure, such as by using an insulating tape, must be used to cover the power and video connectors after connection.

FOCAL LENGTH & FOCUS ADJUSTMENT

This camera supports remote focal length and focal adjustment remotely from our HD CCTV DVR.

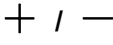
Note: The access paths described below are available only when the camera is connected to our HD CCTV DVR.

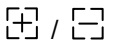
On the DVR live view, click the channel which connects this camera to display in the full screen mode, and select  on the bottom left side of the screen to show the PTZ control panel.

	Zoom in / out max	Click to zoom in on the image to the largest / zoom out on the image to its original size.
	Zoom in / out	Click to zoom in / out the image.
	Focus near / far	Click to adjust the focus of the image.
	Lens Reset	Click for lens calibration when you feel the focus is not clear after each zoom-in / -out.

CAMERA PARAMETERS

This camera series has its own configuration menu.

Note: Below shows how to enter the configuration page when the camera is used with our HD CCTV recorder. To know how to enter the camera menu from other brand's recorder, please check the user manual of the recorder.

On the DVR live view, click the channel which connects this camera to display in the full screen mode, and select  on the bottom left side of the screen to show the PTZ control panel.



Click  to show the camera menu and you can move among sub-menus:



Move among sub-menus.















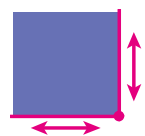





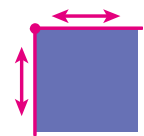





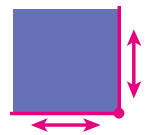





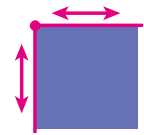





Change settings.



Call the camera parameters menu or enter the currently-selected item.

MENU				DESCRIPTION
EXPOSURE	SHUTTER	AUTO		Automatically adjust the shutter speed for exposure based on the current environment.
		1/30 1/100 1/250 1/500 1/1000 1/2000 1/4000 1/5000 1/50000		Manually choose the shutter speed you need for exposure.
	AGC	0 ~ 65535		Set the level of Auto Gain Control to detect and enhance the image signals when the light condition is poor. The higher the value, the stronger the signals will be enhanced, and the more noise the image will get.
	BRIGHTNESS	0 ~ 255		Set the level to compensate the brightness of the image if needed. The more the value, the brighter the image will be.
	HSBLC	ON / OFF		HSBLC (highlight suppression back light compensation) is used to suppress strong backlight for clearer images. A grey mask will be covered on the source of the strong light.
WHITE BAL	AWB			Automatically adjust the white balance based on the surrounding environment.
	INDOOR			Selected when the camera is installed in the indoor environment.
	OUTDOOR			Selected when the camera is installed in the outdoor environment.
	MANUAL	R GAIN	0 ~ 255	
G GAIN		0 ~ 255		
B GAIN		0 ~ 255		

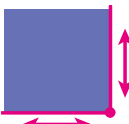
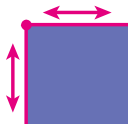
MENU			DESCRIPTION	
DAYNIGHT	EXT	ALS IN DELAY	0 ~ 255 Set the delay time in second after which the day and night switch is made. This is used for the environment where the light condition may change suddenly and usually last for a short time, for example, the entrance of a parking lot. It may cause the day & night mode switching constantly and damage the camera. With this function, the camera will delay the mode switch at night since the light change is temporary and unnecessary to pay attention.	
	B&W		Always keep the day and night mode to night mode.	
	OFF		Always keep the day and night mode to day mode.	
IMAGE	NR	AUTO	Automatically reduce noise in the image based on the current environment.	
		MANUAL	STRENGTH	Set the level to enable noise reduction.
		OFF		Choose to disable this function.
	DWDR	ON / OFF	DWDR is used to increase image recognizability in overexposure and dark areas. Choose ON / OFF enable / disable this function.	
	PRIVACY	OFF		Disable this function.
		ON	COLOR	Choose the color for the area selected in MASK SEL . You can choose NO COLOR to disable this function, MOSAIC for mosaic display, or 1 ~ 14 for different colors.
			MASK SEL	Select the area you want to mask. Up to four areas could be configured.
		MASK DRAW	Set the size of the masked area: 1. Click  and change the size by clicking  ,  ,  and  .  2. Click  again and change the size by clicking  ,  ,  and  .  3. Click  again to finish and exit.	
	MOTION	OFF		Choose to disable motion detection.
		ON (BORDER)	AREA SEL	Select the area you want to detect. Up to four areas could be configured. The area will be framed and flashed when a motion event occurs.
POSITION			Choose ON to show where the area selected in AREA SEL is and set the size of the area: 1. Click  and change the size by clicking  ,  ,  and  .  2. Click  again and change the size by clicking  ,  ,  and  .  3. Click  again to finish and exit.	
SENSITIVITY			Set the sensitivity for motion detection. The larger the value, the more sensitive the detection.	
COLOR			Choose the color for the selected area to show when a motion event occurs: RED / GREEN / BLUE / WHITE .	
TRANS			Choose the transparent level for the selected area when a motion event occurs. The larger the value, the more transparent the area.	

MENU				DESCRIPTION	
IMAGE	MOTION	ON (SOLID)	AREA SEL	Click  to set the area you want to detect. Up to four areas could be configured. The area will be masked and flashed when a motion event occurs.	
			POSITION	Choose ON to show where the area selected in AREA SEL is and set the size of the area: 1. Click  and change the size by clicking  ,  ,  and  . 2. Click  again and change the size by clicking  ,  ,  and  .   3. Click  again to finish and exit.	
			SENSITIVITY	Set the sensitivity for motion detection from 1 to 24 . The larger the value, the more sensitive the detection.	
			COLOR	Choose the color for the selected area to show when a motion event occurs: RED / GREEN / BLUE / WHITE .	
			TRANS	Choose the transparent level for the selected area from 1 ~ 8 when a motion event occurs. The larger the value, the more transparent the area.	
	LSC	ON / OFF		Enable (ON) or disable (OFF) Lens Shading Correction to correct the phenomenon of vignetting when the focal length is short.	
	MIRROR	OFF / ON		Enable (ON) to turn the images horizontally based on your installation situation when necessary.	
	BPC	DYNAMIC			BPC (bad point compensation) is used to compensate dead pixels in the image. Click  to further configure DYNAMIC / STATIC W (white) / STATIC B (black).
		STATIC W			
		STATIC B			
	PICT ADJ	SHARPNESS	0 ~ 15		Set the level of sharpness to enhance the clarity of image detail by adjusting the aperture and sharpening the edges. The more the value, the sharper the image will be.
		CB GAIN	0 ~ 255		Adjust the blue value.
		CR GAIN	0 ~ 255		Adjust the red value.
BLACK LEVEL		-128 ~ 127		Adjust the level of black.	
	GAMMA	0.4 / 0.45 / 0.5		Choose for gamma correction.	
SYSTEM	CAM TITLE	OFF / ON		Set the camera ID.	
	LANGUAGE	ENG / CHI S		Select the language of the menu: English / Simplified Chinese.	
	FORMAT	NTSC / PAL		Choose to change the video system format if needed.	
EXIT	SAVE&END			Save all the changes made and exit.	
	NOT SAVE			Quit without saving.	
	RESET			Reset to factory default values.	